

Movidius Smart Camera

S5131MG000E

Product Features

- Rolling shutter, CMOS series products;
- 512MB RAM and 512MB non-flashable memory;
- Support Software Trigger/Hardware Trigger/Free Run Mode;
- GigE industrial Ethernet interface;
- Abundant I/O interfaces, RS232, isolated input & output;
- Industrial grade M12 connector, IP67 protection;
- Support DC8V~26V wide voltage power supply, adapt to industrial DC12V/24V voltage environments;
- Abundant code reading types, Code128 /EAN, DM/QR, etc.;



Dimensions (mm)

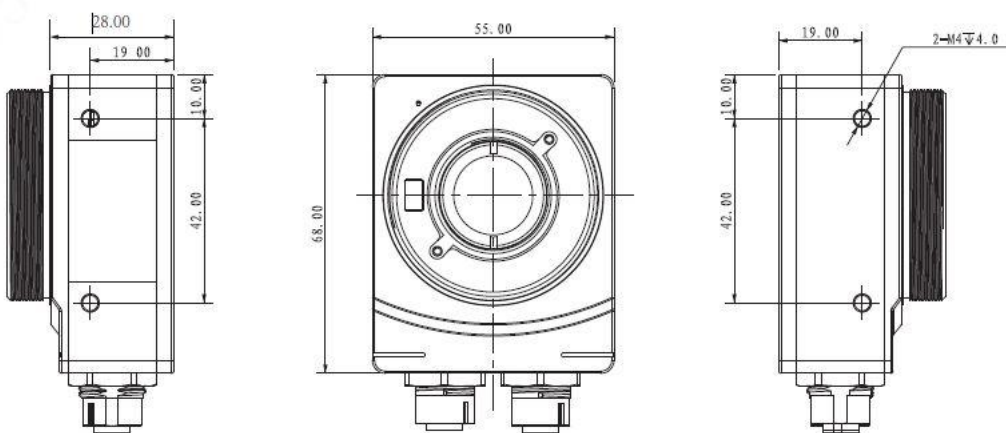

Technical Specifications

Model Name	S5131MG000E
Sensor	1/2" CMOS
Shutter	Global
Resolution	1280 x 1022
Frame Rate	60fps
Mono/Color	Mono
Pixel Size	4.8 x 4.8
Lens Mount	C-mount
Function	Abundant code reading types (Code128/Code39/Code93/EAN etc.; QR/DM/Vericode etc.)
Connector	2 industrial M12 connectors, for Ethernet and GPIO
Ethernet	Code-A, GigE
Software	SVStudio
Sync Mode	Software Trigger/Hardware Trigger/Free Run Mode
LED Indicator	Power, Network, Trigger
Communication Mode	RS232, Ethernet
Communication Protocol	SDK, Serial, TCPServer, TCPClient, Profinet, Modbus TCP
GPIO	12-pin I/O interface, RS232, 1x Opto-isolated input, 3x Opto-isolated output
Power Supply	DC 8V~26V wide voltage input, adapt to industrial DC12V/24V voltage environments
Power Consumption	4.0W
Product Dimensions	68mm x 55mm x 28mm (Non including lens mount and rear case connector)
Protection	IP67 (with the proper lens cover installed correctly)
Shell material	Aluminum alloy
Weight	<200g
Temperature	Storage: - 30°C~+80°C; Operation: - 20°C~+50°C
Operating Humidity	20% ~ 95%, No condensing (with the proper lens cover installed correctly)
Certifications	CE, FCC, KC

© 2021 IRAYPLE. All rights reserved. Design and specifications are subject to change without notice.
Pictures in the document are for reference only, and the actual product shall prevail.